

DIVANO cm 163

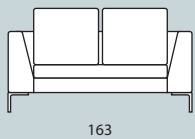

DIVANO cm 193

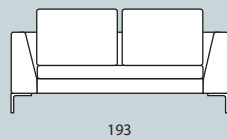

DIVANO cm 223

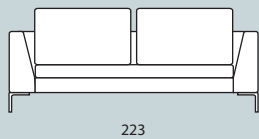

DIVANO cm 276

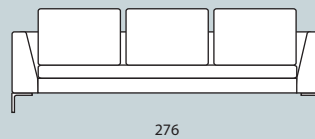

CENTRALE cm 98



LATERALE cm 98

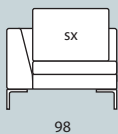

LATERALE cm 139

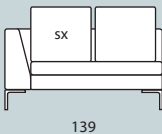

LATERALE cm 169

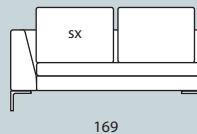

LATERALE cm 199

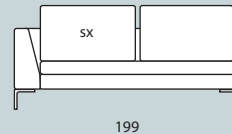

PENISOLA cm 173

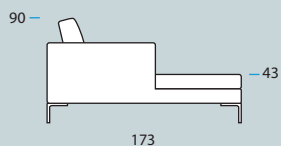

ANGOLO TERMINALE cm 232

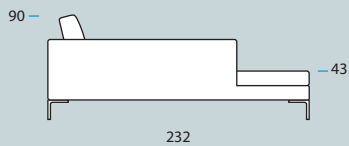

CUSCINO SCHIENALE PER ANGOLO



POUF QUADRATO cm 96



POUF RETTANGOLARE cm 96 X 50

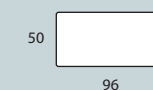
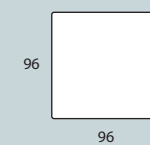
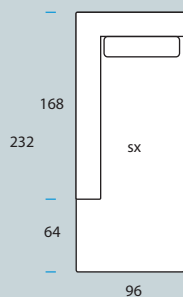
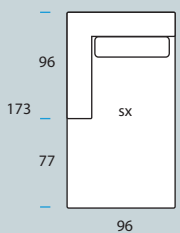

COMPOSIZIONE 1

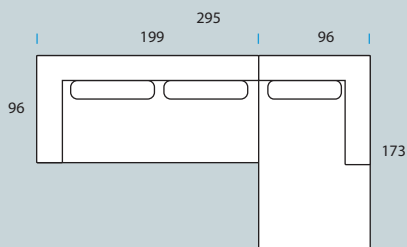

COMPOSIZIONE 2

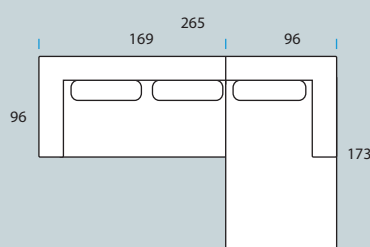

COMPOSIZIONE 3

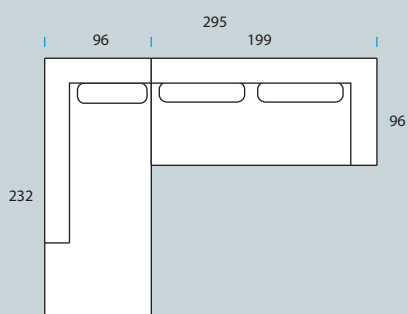

COMPOSIZIONE 4

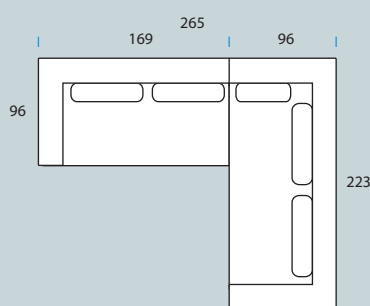

POUF NICO CILINDRICO



CUSCINO 56 X 56 cm IN MOLLA PIUMA CON INSERTO

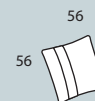

POUF GRANDE JOKER

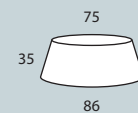

CUSCINO 56 X 56 cm IN MOLLA PIUMA



POUF MEDIO JOKER



CUSCINO 61 X 25 cm IN MOLLA PIUMA



POUF PICCOLO JOKER



SERVETTO "SHARE" IN NIKRON BIANCO

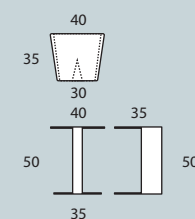

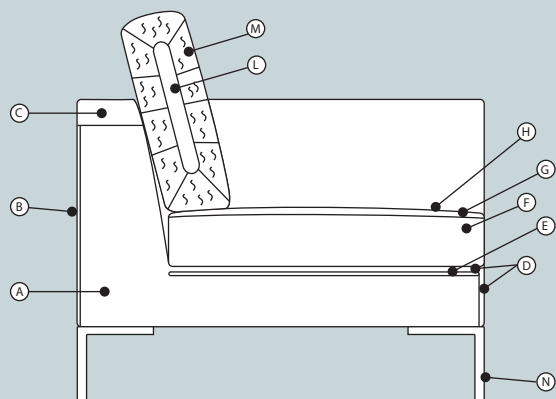

### CARATTERISTICHE TECNICHE

**A** Struttura in legno massello, multistrati, pannelli in fibra

### IMBOTTITURA STRUTTURA

**B** Resinato accoppiato di vellutino  
**C** Poliuretano espanso D 40 PK  
**D** Poliuretano espanso D 21 T  
**E** Cinghie elastiche

### CUSCINO DI SEDUTA

**F** Poliuretano espanso D 40 IP  
**G** Poliuretano espanso D 35 AT  
**H** Resinato gr. 150 con vellutino

### CUSCINO SCHIENALE

**L** Poliuretano espanso D 25 E  
**M** Mollapiuma® 32S sterilizzata ed anallergica divisa a scomparti in fodera di tela antipiuma

### N PIEDINO

**TIPO A** Angolare in acciaio cromato  
**TIPO B** Alluminio lucido  
**TIPO C** Alluminio bronzato

### TECHNICAL CHARACTERISTICS

**A** Structure in solid wood, multi-layer wood, fibreboard and wood particleboard panels

### STRUCTURE PADDING

**B** Resin-coated fabric bonded with velvetin  
**C** Expanded polyurethane D 40 PK  
**D** Expanded polyurethane D 21 T  
**E** Elastic straps

### SEAT CUSHIONS

**F** Expanded polyurethane D 40 IP  
**G** Expanded polyurethane D 35 AT  
**H** Resin-coated fabric gr. 150 with velvetin

### BACK CUSHIONS

**L** Expanded polyurethane D 25 E  
**M** Non-allergenic and sterilized Mollapiuma® 32S down divided into compartments, with feather-proof fabric lining

### N FEET

**TYPE A** Angle bracket in chrome steel  
**TYPE B** Polished aluminum  
**TYPE C** Bronzed aluminum

Deas srl si riserva la facoltà di modificare in qualunque momento e senza preavviso le caratteristiche tecniche degli elementi illustrati nel presente catalogo. Declina ogni responsabilità per eventuali inesattezze contenute nello stesso.