

DIVANO CM 178
DIVANO CM 208
DIVANO CM 238

DIVANO CM 268 (CON 3 SEDUTE)

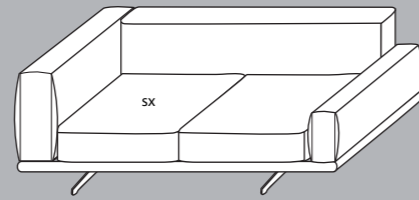

DIVANO ANGOLARE CM 178
DIVANO ANGOLARE CM 208
DIVANO ANGOLARE CM 238

DIVANO ANGOLARE CM 268 (CON 3 SEDUTE)

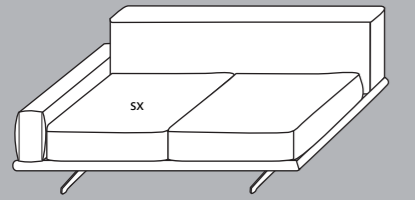

ELEMENTO LATERALE CM 152
ELEMENTO LATERALE CM 182
ELEMENTO LATERALE CM 212

ELEMENTO LATERALE CM 242 (CON 3 SEDUTE)

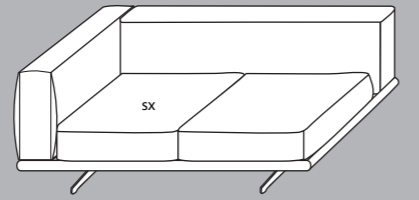

ANGOLARE CM 182
ANGOLARE CM 212

ANGOLARE CM 242 (CON 3 SEDUTE)

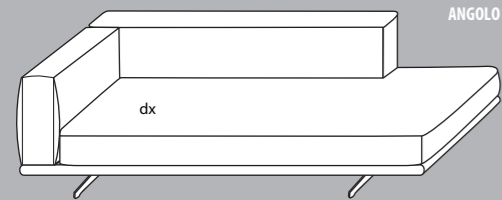

ANGOLO TERMINALE CM 230

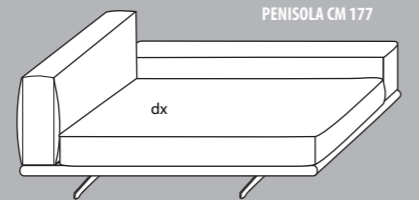

PENISOLA CM 177

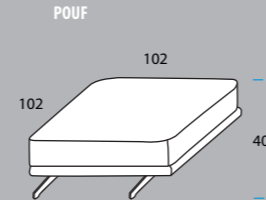

POUF

POUF NICO



POUF NICO GRANDE

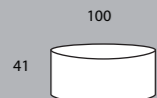

SERVETTO CLICK

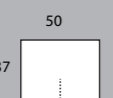

POLTRONA P007



CUSCINI SCHIENALI IN MOLLAPIUMA
CON ORLO RIFINITO A CONTRASTO



POUF JOKER SPICCHIO

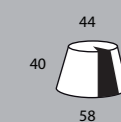

POUF GRANDE JOKER

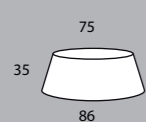

COMPOSIZIONI MODELLO SELFIE
COMPOSIZIONE 5

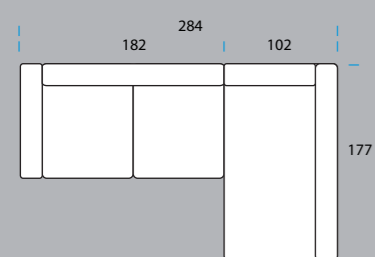

COMPOSIZIONE 6

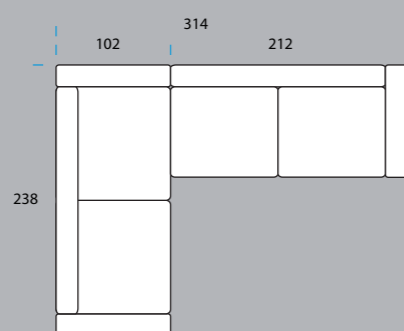

COMPOSIZIONE 7

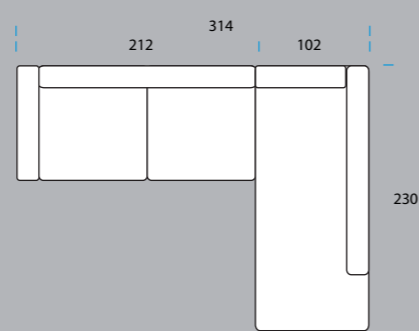

Selfi

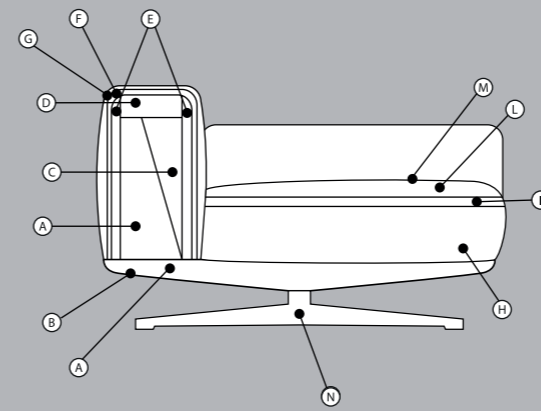

CARATTERISTICHE TECNICHE SELFIE

STRUTTURA BASE

A Struttura in legno massello e pannelli in fibra di legno con baionette in ferro FE 37 zincate per il fissaggio di braccioli e schienale

IMBOTTITURA STRUTTURA

B Resinato pressato con maglia

IMBOTTITURA BRACCIOLO E SCHIENALE

C Poliuretano espanso D 30 T

D Poliuretano espanso D 30 SE

E Poliuretano espanso D 21 SS

F Resinato gr.200

G Resinato gr.200 + vellutino

SEDUTA

H Poliuretano espanso D 40 EM

I Poliuretano espanso D 35 AT

L Poliuretano espanso D 30 SE

M AGS 300/cotone + accoppiato mm.3

N Basamento in acciaio satinato con vernice trasparente protettiva

TECHNICAL CHARACTERISTICS SELFIE

STRUCTURE

A Structure in solid wood, fibreboard wood panels with galvanized FE 37 iron bayonets for fastening to armrests and backrest

STRUCTURE PADDING

B Resin-treated coupled fabric

ARMREST AND BACKREST PADDING

C Expanded polyurethane D 30 T

D Expanded polyurethane D 30 SE

E Expanded polyurethane D 21 SS

F Resin-coated fabric gr.200

G Resin-coated fabric gr.200 + velveteen

SEAT CUSHIONS

H Expanded polyurethane D 40 EM

I Expanded polyurethane D 35 AT

L Expanded polyurethane D 30 SE

M AGS 300/cotton with coupled

N Base in satin steel with transparent protective varnish

Deas srl si riserva la facoltà di modificare in qualunque momento e senza preavviso le caratteristiche tecniche degli elementi illustrati nel presente catalogo. Declina ogni responsabilità per eventuali inesattezze contenute nello stesso.

Selfi