

STRUTTURA: La struttura in legno massello e multistrati è ricoperta da poliuretano espanso a quote differenziate e resinato accoppiato con maglia per l'effetto "morbido". Il molleggio è affidato a cinghie elastiche di elevato profilo tecnologico che vengono applicate meccanicamente.

SCHIENALI: I due tipi di schienali sono imbottiti in mollapiuma® lavata e sterilizzata divisa a scomparti, il tutto rivestito in tela di cotone 100%, spigatino antipiuma. Il rullo posteriore in poliuretano espanso è rivestito in resinato accoppiato con maglia.

I piedi sono in legno con fondo in gomma antiscivolo. Il gancio a "L" delle sedute e lo spinotto delle giunzioni sono in metallo zincato.

Gli elementi confezionati in tessuto sono completamente e facilmente sfoderabili.

STRUCTURE: it has a multi-plywood solid wood structure covered in foam polyurethane in differentiated densities, and resin bonded with fibre for a "soft" effect. It has high-tech elastic strap springs, which are mechanically applied.

BACKS: The two types of back are padded with washed and sterilized "mollapiuma®", divided into sections, all upholstered in feather-resistant 100% cotton fabric. The rear foam polyurethane roll cushion is upholstered in resin bonded with fibre.

It has wood feet with non-slip rubber bottoms. The "L"-shaped hook of the seats and the joint pins are in galvanized metal.

All fabric covers can be completely and easily removed.

STRUCTURE : La structure en bois massif et en multiplis est recouverte de polyuréthane expansé à densités différenciées et résine synthétique doublé à un tissu élastique pour un effet "moelleux". La suspension est assurée par sangles élastiques technologiquement avancées et appliquées mécaniquement.

DOSSIERS : Les deux types de dossiers sont garnis en flocons de plumes (mollapiuma®) lavés, stérilisés et séparés en compartiments. Ils sont revêtus avec une toile 100% coton à chevrons anti-plume. Le coussin rond du dos en polyuréthane expansé est revêtu en résine synthétique doublé à un tissu élastique.

Les pieds sont en bois avec une embase en caoutchouc anti-glisse. Le crochet en "L" des assises et la cheville assurant la fixation sont en métal galvanisé.

Les éléments réalisés en tissu sont entièrement et facilement déhoussables.

STRUKTUR: die Struktur besteht aus mehrschichtigem Maserholz und ist mit Polyurethanschaumstoff in unterschiedlicher Höhe und mit Harz versetztem Jerseystoff, für eine "weiche" Wirkung verkleidet. Die Federung besteht aus elastischen Gurten mit hohem technologischen Profil, die mechanisch befestigt werden.

RÜCKEN: Die zwei Rückenmodelle sind mit gewaschenen und sterilisierten Daunenfedern® gepolstert und abgesteppt, das Ganze ist mit 100% Baumwollstoff, daunensicher geköpert, bezogen. Die hintere Rolle ist aus Polyurethanschaumstoff und mit Harz versetztem Jerseystoff bezogen.

Die Füße sind aus Holz mit rutschfester Unterfläche aus Gummi. Der "L"-förmige Haken der Sitze und der Bolzen der Verbindungen sind aus verzinktem Metall.

Die mit Stoff konfektionierten Elemente sind komplett und leicht abziehbar.

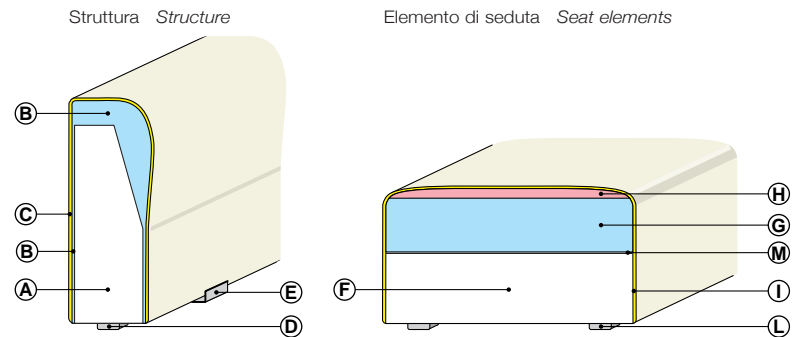

Sistema di aggancio delle sedute.
Seat hooking system.

Cuscino schienale 80x80 Back cushion 80x80

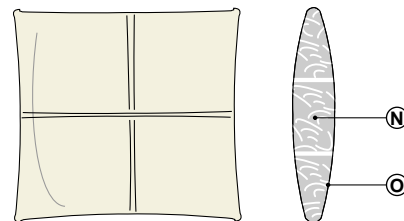

Cuscino schienale con rullo back cushion with roll cushion

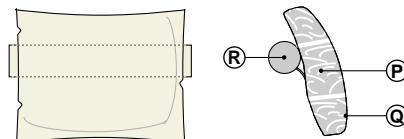

CONVERSIONE ROMEO

STRUTTURA

- (A) Struttura completa in legno massello e multistrati
- (B) Riuletano espanso D40 T
- (C) Resinato accoppiato con maglia
- (D) Piedini in legno con fondo antiscivolo in gomma
- (E) Gancio ad "L" in metallo zincato

REMOVOD SEDUTA

- (F) Struttura completa in legno massello e multistrati
- (G) Riuletano espanso D40 IP
- (H) Riuletano espanso D30 con struttura a dente
- (I) Resinato accoppiato con maglia
- (L) Piedini in legno con fondo antiscivolo in gomma
- (M) Orgie di stoffe

CONVERSIONE ROMEO

- (N) Mollapiuma®
- (O) Tela di cotone 100% spigatino antipiuma divisa a scomparti

CONVERSIONE ROMEO

- (P) Mollapiuma®
- (Q) Tela di cotone 100% spigatino antipiuma divisa a scomparti
- (R) Riuletano D25 con rivestimento resinato accoppiato con maglia

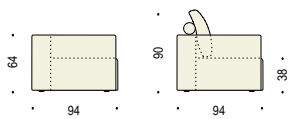

ELEMENTI COMPONENTI

Elementi struttura

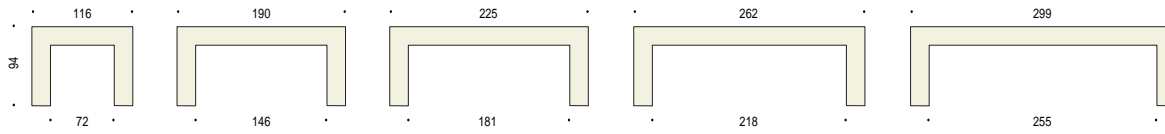

Elementi struttura "laterale DX/SX"

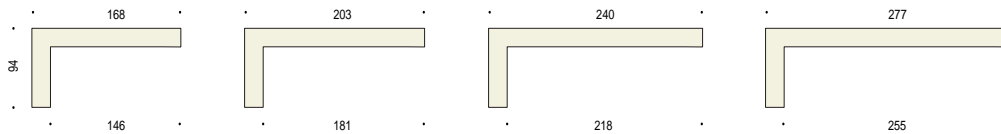

Elementi di seduta

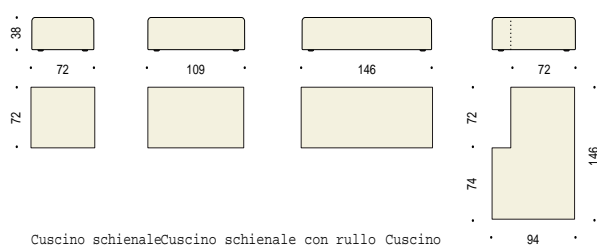

Cuscino schienale Cuscino schienale con rullo Cuscino

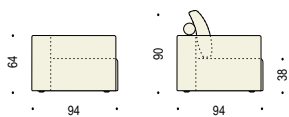
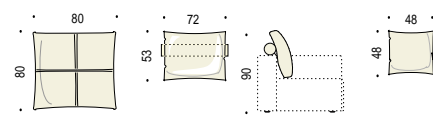

POLTRONA

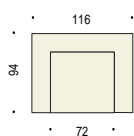

DIVANO 2 POSTI cm.190

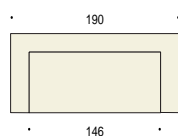

DIVANO 2 POSTI MEDIO cm.225

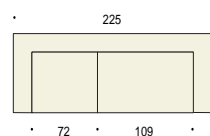

DIVANO 3 POSTI cm.262

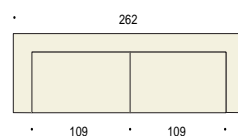

DIVANO 3 POSTI MAXI cm.299

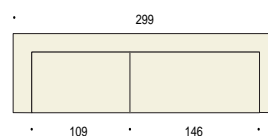

I diversi utilizzi del cuscino schienale con rullo.
A variety of uses for the back cushion with roll cushion.

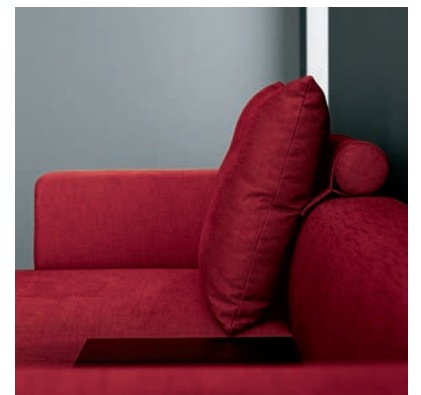

TECHNICAL FEATURES

STRUCTURE

- (A) Structure entirely in steel welded and nitrided parts
- (B) Foam polyurethane D40 T
- (C) Resin bonded with jersey fabric
- (D) Wool feet with non-slip rubber bottom
- (E) 1" shaped locking glides in steel

SEAT ELEMENTS

- (F) Structure entirely in steel welded and nitrided parts
- (G) Foam polyurethane D40 IP
- (H) Foam polyurethane D30 S with diamond shaped contours
- (I) Resin bonded with jersey fabric
- (L) Wool feet with non-slip rubber bottom
- (M) Elastic straps

BACKCUSHION

- (N) *Majure®
- (O) Feather-resistat 100% cotton fabric, divided into sections

BACKCUSHION WITH ROLL CUSHION

- (P) *Majure®
- (Q) Feather-resistat 100% cotton fabric, divided into sections
- (R) Polyurethane D25 with upfoam stay in resin bonded with jersey fabric