

Elementi componibili

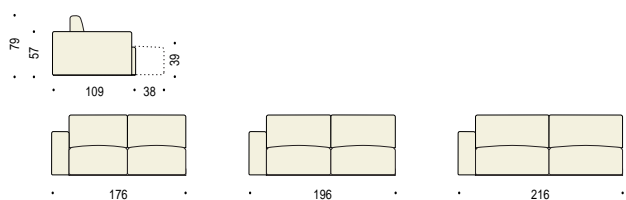

Penisola DX/SX

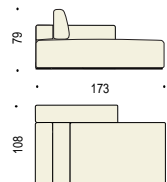

Pouf quadrato

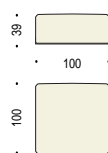

POGGIATESTA cm.61

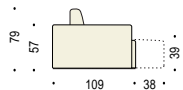

DIVANO 3 POSTI MAXI cm.239

DIVANO 3 POSTI cm.219

DIVANO 2 POSTI GRANDE cm.199

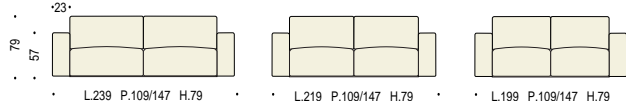

COMPOSIZIONE 1: Laterale cm.196 + Penisola

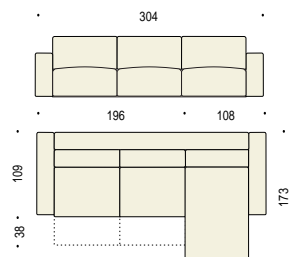

**STRUTTURA:** La struttura in legno è ricoperta da poliuretano espanso a quote differenziate e resinato accoppiato a maglina. Le sedute scorrevoli sono in legno con telaio in ferro verniciato per lo scorrimento in avanti di cm.38 della seduta stessa.

Il molleggio è affidato a cinghie elastiche di elevato profilo tecnologico che vengono applicate meccanicamente.

**IMBOTTITURA:** L'imbottitura della seduta è in poliuretano espanso a quote differenziate con sagomatura a diamante; il tutto è ricoperto da resinato accoppiato a maglina.

Schienale in Mollapiuma® divisa a scomparti con fodera di tela antipiuma bianca con inserto posteriore in poliuretano espanso. Abbiamo inserito nello schienale un pannello in multistrati con baionette in ferro per l'aggancio dello schienale stesso alla struttura posteriore.

Struttura telaio dello scorrevole in ferro verniciato con ruote in Nylon POM.

Completamente smontabile per un più agevole trasporto e facilmente sfoderabile.

**STRUCTURE:** The wood structure is covered in foamed polyurethane in differentiated densities and resin bonded with jersey fabric. It has wood sliding seats with a lacquered iron frame so that the seat itself can slide 38 cm forwards.

It has high-tech elastic strap springs, which are mechanically attached.

**PADDING:** The seat is padded with foamed polyurethane in differentiated densities in a diamond shape. It is all covered in resin bonded with jersey fabric. The back is in Mollapiuma®, and divided into sections and upholstered in a white feather-resistant fabric with an insert at the back in foamed polyurethane. We have inserted a plywood panel with iron bayonets in the back to fasten the back itself to the rear structure.

The sliding frame is in lacquered iron with Nylon "POM" wheels.

It can all be dismantled, for easy transport and all its covers can be easily removed.

**STRUCTURE:** La structure en bois est recouverte de polyuréthane expansé en différentes épaisseurs et de résinate uni à du jersey. Les assises mobiles sont en bois avec un châssis en fer verni qui permet de faire glisser l'assise de 38 cm vers l'avant.

Les suspensions sont en sangles élastiques de haut profil technologique et sont appliquées mécaniquement.

**GARNISSAGE:** Le garnissage de l'assise est en polyuréthane expansé en différentes épaisseurs avec façonnage à losanges; le tout est recouvert de résinate uni à du jersey. Dossier compartimenté et matelassé en Mollapiuma® avec housse en tissu anti-duvet blanc et insert arrière en polyuréthane expansé. Nous avons inséré dans le dossier un panneau multiplex avec un mécanisme à baionette en fer pour la fixation du dossier à la structure arrière.

Structure du châssis mobile en fer verni et roulettes en Nylon POM.

Facilement déhoussable et entièrement démontable pour une plus grande facilité de transport.

**KORPUS:** Der Korpus aus Holz ist mit Polyurethanschaumstoff in unterschiedlicher Stärke und mit Jersey verbundenem Resinat beschichtet. Die verschiebbaren Sitze sind aus Holz mit lackiertem Eisenrahmen für den Auszug der Sitzfläche von 38 cm nach vorn. Die Federung besteht aus zuverlässigen elastischen Gurten mit hochtechnologischem Profil, die mechanisch angebracht werden.

**POLSTERUNG:** Die Polsterung der Sitzfläche ist aus Polyurethanschaumstoff mit unterschiedlicher Stärke mit Diamantformung, alles zusammen ist mit Jersey verbundenem Resinat bezogen. Rücken aus Federdaunen®, abgesteppt mit Bezug aus daunensicherem, weissem Stoff mit rückseitigem PU-Schaumeinsatz. Wir haben in den Rücken ein mehrschichtiges Paneel mit Eisenbaionetten für das Einhängen des Rückens an der rückseitigen Struktur, eingesetzt.

Rahmenstruktur des Auszugs in lackiertem Eisen mit Laufrollen in Nylon POM.

Für einen leichten Transport ganz zerlegbar, Bezug einfach abziehbar.

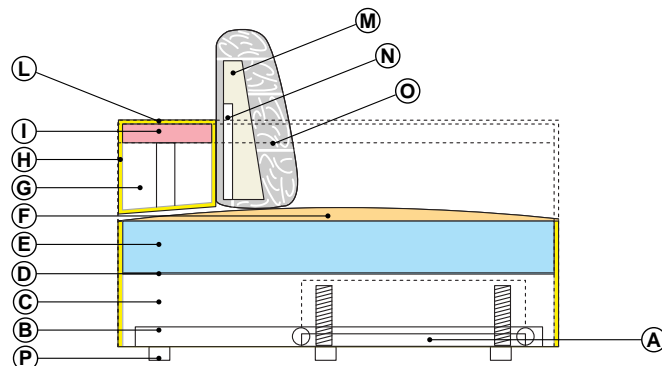

COMPLETAMENTE SMONTABILE . IT CAN BE COMPLETELY DISMANTLED

CONVERSIONE TONNE

- Ⓐ Telaio in ferro REY verniciato a fuoco con baionette in REY zincate per il fissaggio di braccioli. Rote per scorrimento in "Rote" per in ferro REY.
- Ⓑ Telaio scorrevole in ferro REY verniciato a fuoco.
- Ⓒ Telaio in legno massello con tappezzerie in particelle di legno.
- Ⓓ Ongie di stoffe.
- Ⓔ Poluretano espanso D35E.
- Ⓕ Poluretano espanso D30S con sagomatura a diamante.
- Ⓖ Basso seduto in particelle di legno e fibra di legno con baionette in REY zincate per il fissaggio di braccioli.
- Ⓗ Poluretano espanso D30 I.
- Ⓘ Poluretano espanso D40 K.
- Ⓛ Resinato accoppiato con maglina.
- Ⓜ Poluretano espanso D25 S.

- Ⓝ Pannello in multistrato con baionette in REY zincate per il fissaggio degli schienali.
- Ⓞ Mollapiuma® divisa a scomparti in fodera di tela antipiuma bianca.
- Ⓟ Retiro in legno con forata svedese in grana.



Divano smontato nei suoi elementi.  
Sofa with dismantled elements.

#### TECHNICAL FEATURES

- Ⓐ Bleached RE7 iron frame with galvanized RE7 iron brackets for fastening to armrests. \*ROM wheels for sliding and pins in RE7 iron
- Ⓑ Sliding frame in bleached RE7 iron
- Ⓒ Slid wood frame with wool particle board fillers
- Ⓓ Elastic straps
- Ⓔ Foam polyurethane D35 SE
- Ⓕ Foam polyurethane D30 S with diamond shaped contour.
- Ⓖ Backrest block in wool particle board and MW with galvanized RE7 iron brackets for fastening to armrests
- Ⓗ Foam polyurethane D30 T
- Ⓘ Foam polyurethane D40 K
- Ⓖ Reinforced with jersey fabric
- Ⓜ Foam polyurethane D25 S
- Ⓝ Plywood panel with galvanized RE7 iron brackets for fastening to back
- Ⓞ Milipuz® divided into sections in white feather-resistant fabric
- Ⓟ Wool foot with non-slip rubber bottom