

DIVANO CM 178
DIVANO CM 208
DIVANO CM 238

DIVANO CM 268
(CON 3 SEDUTE E 3 SCHIENALI)

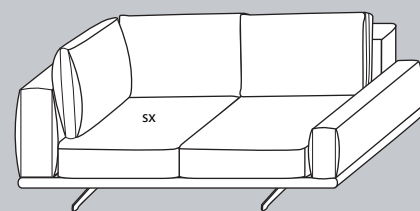

DIVANO ANGOLARE CM 178
DIVANO ANGOLARE CM 208
DIVANO ANGOLARE CM 238

DIVANO ANGOLARE CM 268
(CON 3 SEDUTE E 3 SCHIENALI)

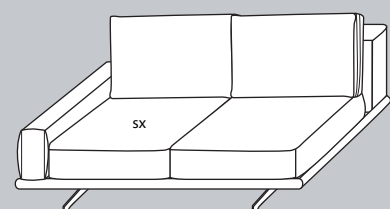

ELEMENTO LATERALE CM 152
ELEMENTO LATERALE CM 182
ELEMENTO LATERALE CM 212

ELEMENTO LATERALE CM 242
(CON 3 SEDUTE E 3 SCHIENALI)

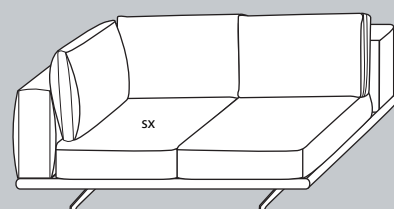

ANGOLARE CM 182
ANGOLARE CM 212

ANGOLARE CM 242
(CON 3 SEDUTE E 3 SCHIENALI)

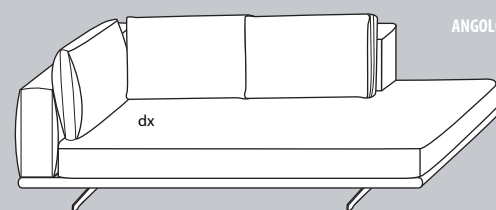

ANGOLO TERMINALE CM 230

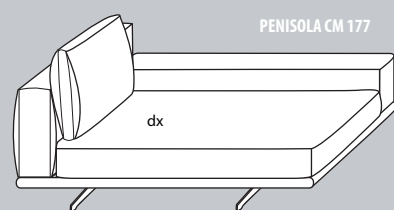

PENISOLA CM 177

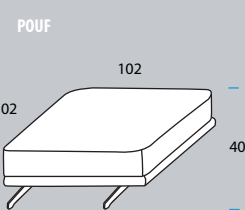

POUF

POUF NICO



POUF NICO GRANDE

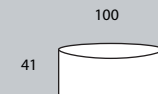

POUF GRANDE JOKER

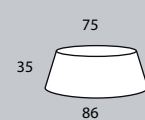

POUF MEDIO JOKER

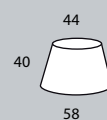

POGGIATESTA

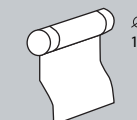

SERVETTO CLICK

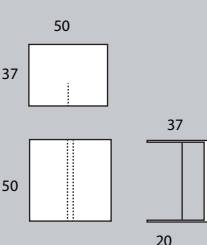

COMPOSIZIONI MODELLO HAPPY
COMPOSIZIONE 1

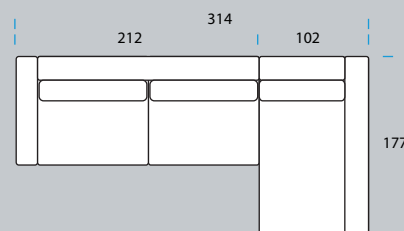

COMPOSIZIONE 2

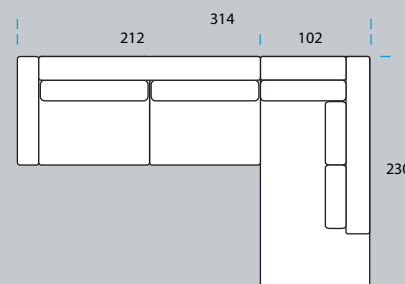

COMPOSIZIONE 3

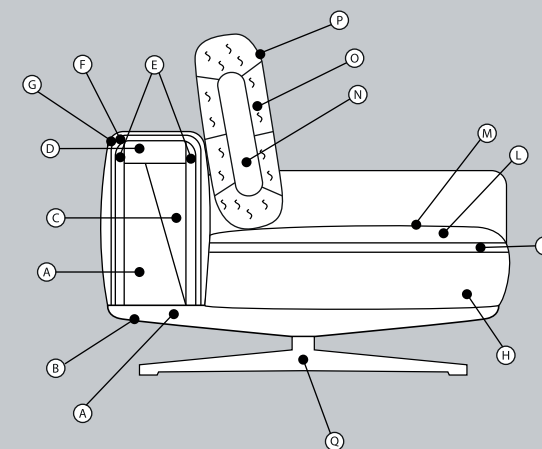
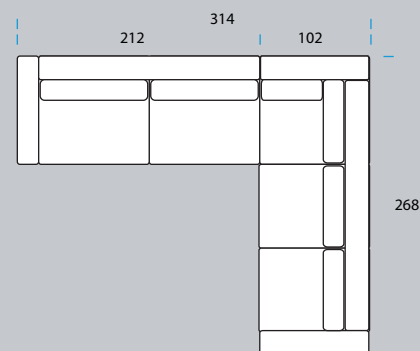

CARATTERISTICHE TECNICHE HAPPY

STRUTTURA BASE

A Struttura in legno massello e pannelli in fibra di legno con baionette in ferro FE 37 zincate per il fissaggio di braccioli e schienale

IMBOTTITURA STRUTTURA

B Resinato pressato con maglina

IMBOTTITURA BRACCIOLO E SCHIENALE

C Poliuretano espanso D 30 T

D Poliuretano espanso D 30 SE

E Poliuretano espanso D 21 SS

F Resinato gr.200

G Resinato gr.200 + vellutino

SEDUTA

H Poliuretano espanso D 40 EM

I Poliuretano espanso D 35 AT

L Poliuretano espanso D 30 SE

M AGS 300/cotone + accoppiato mm.3

SCHIENALE

N Poliuretano espanso D 25 E

O Mollapiuma® 32 S sterilizzata e anallergica divisa a scomparti

P Tela antipiuma

Q Basamento in acciaio satinato con vernice trasparente protettiva

TECHNICAL CHARACTERISTICS HAPPY

STRUCTURE

A Structure in solid wood, fibreboard wood panels with galvanized FE 37 iron bayonets for fastening to armrests and backrest

STRUCTURE PADDING

B Resin-treated coupled fabric

ARMREST AND BACKREST PADDING

C Expanded polyurethane D 30 T

D Expanded polyurethane D 30 SE

E Expanded polyurethane D 21 SS

F Resin-coated fabric gr.200

G Resin-coated fabric gr.200 + velveteen

SEAT CUSHIONS

H Expanded polyurethane D 40 EM

I Expanded polyurethane D 35 AT

L Expanded polyurethane D 30 SE

M AGS 300/cotton with coupled

BACK CUSHIONS

N Expanded polyurethane D 25 E

O Non-allergenic and sterilized Mollapiuma® 32 S down divided into compartments

P Feather-proof fabric lining

Q Base in satin steel with transparent protective varnish

Deas srl si riserva la facoltà di modificare in qualunque momento e senza preavviso le caratteristiche tecniche degli elementi illustrati nel presente catalogo. Declina ogni responsabilità per eventuali inesattezze contenute nello stesso.