

DIVANO cm 198

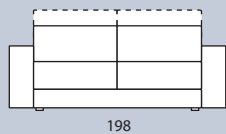

DIVANO cm 218

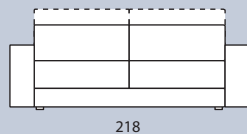

DIVANO cm 238

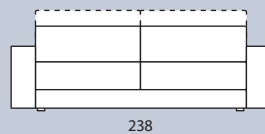

DIVANO COMPOSTO cm 308

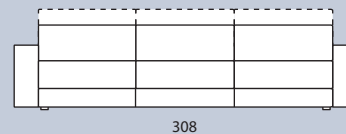

PENISOLA

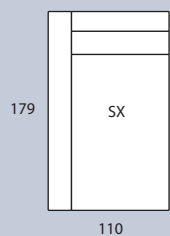
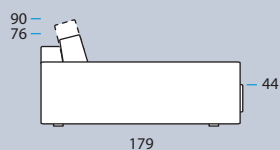

ELEMENTO LATERALE cm 176

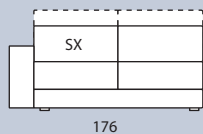

ELEMENTO LATERALE cm 196

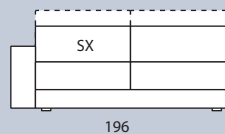

ELEMENTO LATERALE cm 216

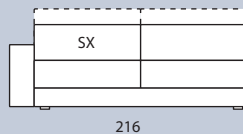

ELEMENTO CENTRALE cm 88



ELEMENTO LATERALE cm 110

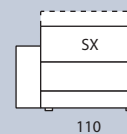

ANGOLO RETTO cm 101 (SCHIENALI FISSI)

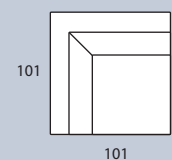
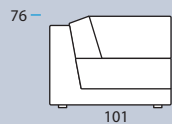

POUF RETTANGOLARE cm 101 x 54



SERVETTO "SHARE" IN NIKRON BIANCO

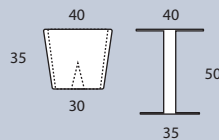
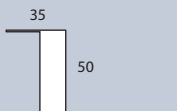

SERVETTO "JO" IN NIKRON BIANCO

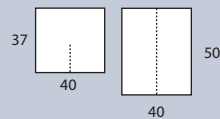
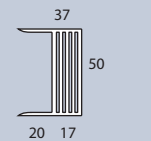

POUF NICO CILINDRICO



POUF GRANDE JOKER

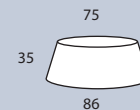

POUF MEDIO JOKER

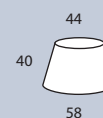

POUF PICCOLO JOKER



COMPOSIZIONE 1

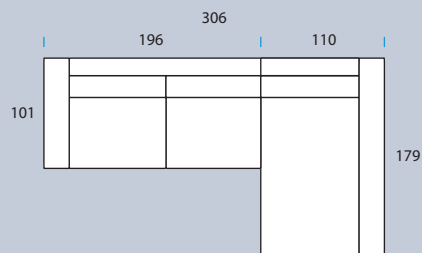

COMPOSIZIONE 2

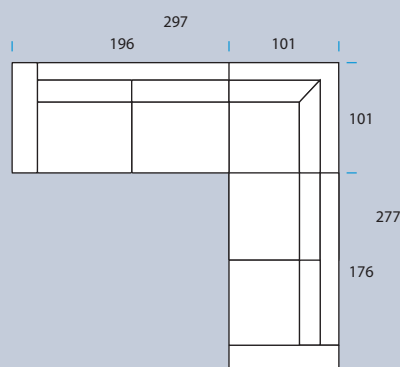

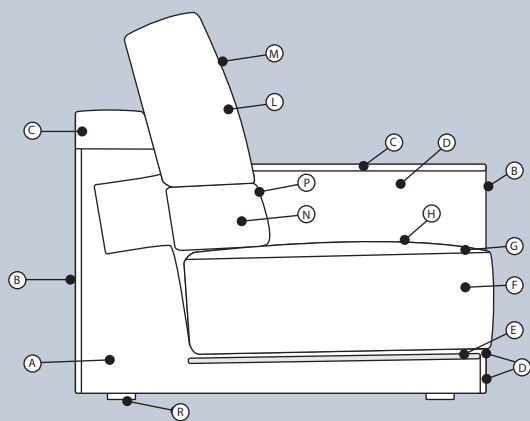

CARATTERISTICHE TECNICHE

A Struttura in legno massello, multistrati, pannelli in fibra e particelle di legno con baionette in ferro FE 37 zincate per il fissaggio dei braccioli

IMBOTTITURA STRUTTURA

B Resinato accoppiato di vellutino
C Poliuretano espanso D 40 T
D Poliuretano espanso D 21 T
E Cinghie elastiche

CUSCINO DI SEDUTA

F Poliuretano espanso D 30 SE
G Poliuretano espanso D CM35 HR
H Tecnoform gr. 300 con vellutino

CUSCINO SCHIENALE

L Poliuretano espanso D 21 SH3
M Tecnoform gr. 300 con vellutino

CUSCINO SCHIENALE (POGGIARENI)

N Poliuretano espanso D 21 T
P Resinato gr. 100 con vellutino

R Piedini polipropilene antiurto

TECHNICAL CHARACTERISTICS

A Structure in solid wood, multi-layer wood, fibreboard and wood particleboard panels with armrest feature bayonet anchoring in zinc-coated metal (FE 37)

STRUCTURE PADDING

B Resin-coated fabric bonded with velvetin
C Expanded polyurethane D 40 T
D Expanded polyurethane D 21 T
E Elastic straps

SEAT CUSHIONS

F Expanded polyurethane D 30 SE
G Expanded polyurethane D CM35 HR
H Tecnoform gr. 300 with velvetin

BACK CUSHIONS

L Expanded polyurethane D 21 SH3
M Tecnoform gr. 300 with velvetin

BACK CUSHIONS (LOINREST)

N Expanded polyurethane D 21 T
P Resin-coated fabric gr. 100 with velvetin

R Shock absorbent feet

Deas srl si riserva la facoltà di modificare in qualunque momento e senza preavviso le caratteristiche tecniche degli elementi illustrati nel presente catalogo. Declina ogni responsabilità per eventuali inesattezze contenute nello stesso.