

CON SCHIENALE "MOOD"

CON SCHIENALE "FREE"

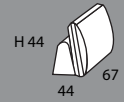

SCHIENALE "MOOD" COMPLETO

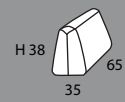

SCHIENALE FREE

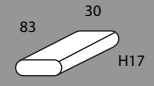

BRACCIOLO CON FASCIA

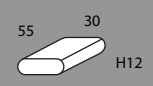

BRACCIOLO CORTO

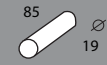

BRACCIOLO CILINDRICO

DIVANI COMPOSTI

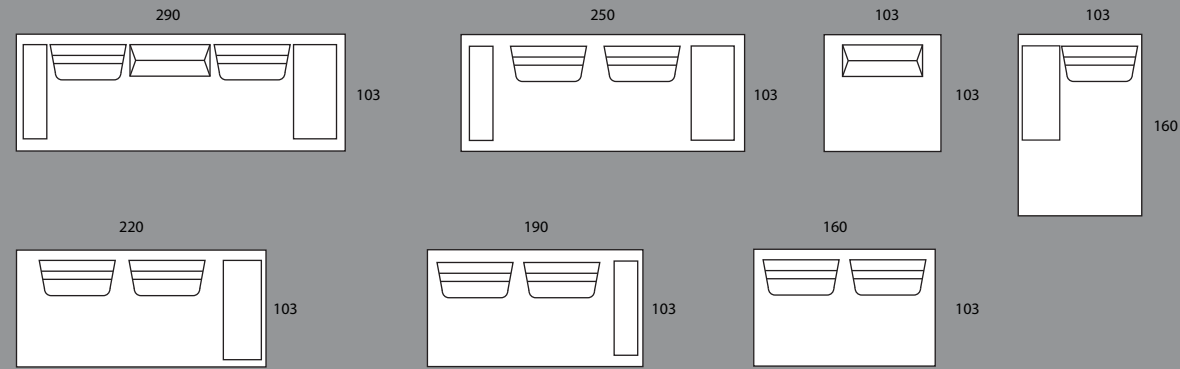

ESEMPI DI COMPOSIZIONI

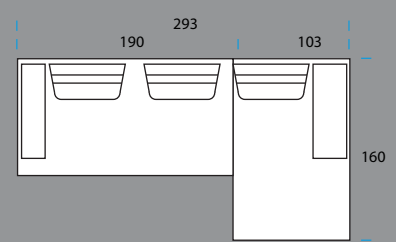

COMPOSIZIONE 2

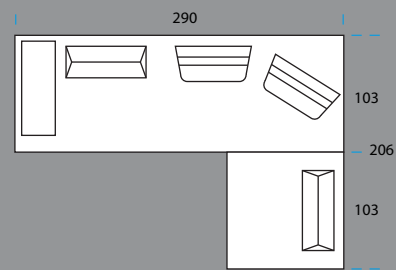

COMPOSIZIONE 3

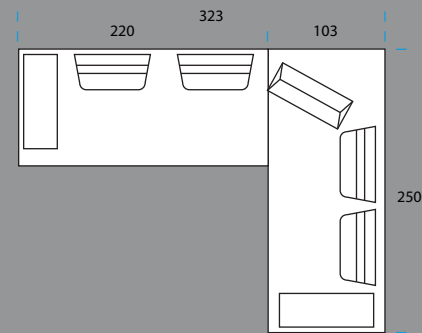

COMPOSIZIONE 4

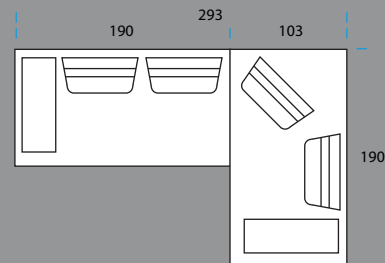

TAVOLINO MY WOOD

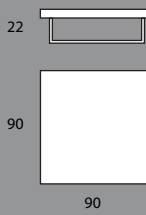

POUF GRANDE JOKER

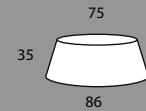

SERVETTO "JO" IN NIKRON BIANCO

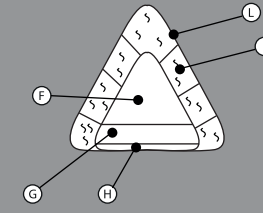
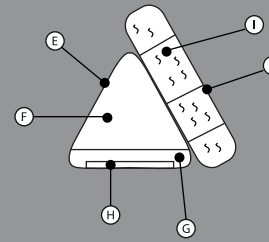
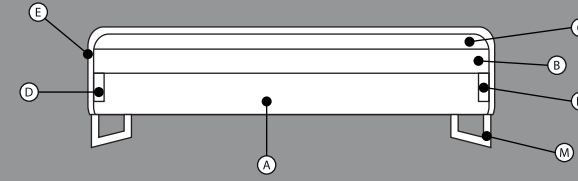
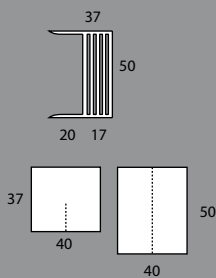

CARATTERISTICHE TECNICHE FREEMOOD

STRUTTURA

A Struttura portante in legno massello di abete e multistrati con pannelli in fibra di legno

IMBOTTITURA STRUTTURA

- B Poliuretano espanso D 40 EM
- C Poliuretano espanso D 35 AT
- D Poliuretano espanso D 21 T
- E Tecnoform gr.300 con vellutino

SCHIENALE "MOOD" TRAPEZIO SCHIENALE

- E Tecnoform gr.300 con vellutino
- F Poliuretano espanso D 30 E
- G Poliuretano espanso D 30 OSCM
- H Materiale antiscivolo

CUSCINO SCHIENALE

- I Mollapiuma® 32 S sterilizzata e anallergica divisa a scomparti
- L Tela antipiuma bianca

SCHIENALE "FREE"

- F Poliuretano espanso D 30 E
- G Poliuretano espanso D 30 OSCM
- H Materiale antiscivolo
- I Mollapiuma® 32 S sterilizzata e anallergica divisa a scomparti
- L Tela antipiuma bianca

M Piedini acciaio color carbonio

TECHNICAL CHARACTERISTICS FREEMOOD

STRUCTURE

A Structure in solid pine wood, multi-layer wood, fibreboard wood

STRUCTURE PADDING

- B Expanded polyurethane D 40 EM
- C Expanded polyurethane D 35 AT
- D Expanded polyurethane D 21 T
- E Tecnoform gr.300 with velveteen

TRAPEZE BACK "MOOD"

- E Tecnoform gr.300 with velveteen
- F Expanded polyurethane D 30 E
- G Expanded polyurethane D 30 OSCM
- H Antislip material

BACK CUSHIONS

- I Non-allergenic and sterilized Mollapiuma® 32 S down divided into compartments
- L Feather-proof fabric lining

TRAPEZE BACK "FREE"

- F Expanded polyurethane D 30 E
- G Expanded polyurethane D 30 OSCM
- H Antislip material
- I Non-allergenic and sterilized Mollapiuma® 32 S down divided into compartments
- L Feather-proof fabric lining

M Foot steel, carbon color

Deas srl si riserva la facoltà di modificare in qualunque momento e senza preavviso le caratteristiche tecniche degli elementi illustrati nel presente catalogo. Declina ogni responsabilità per eventuali inesattezze contenute nello stesso.